

- Applications :

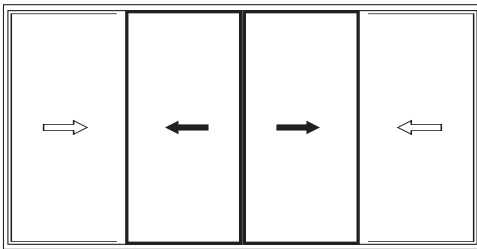

- Coupes (échelle 1/3) :

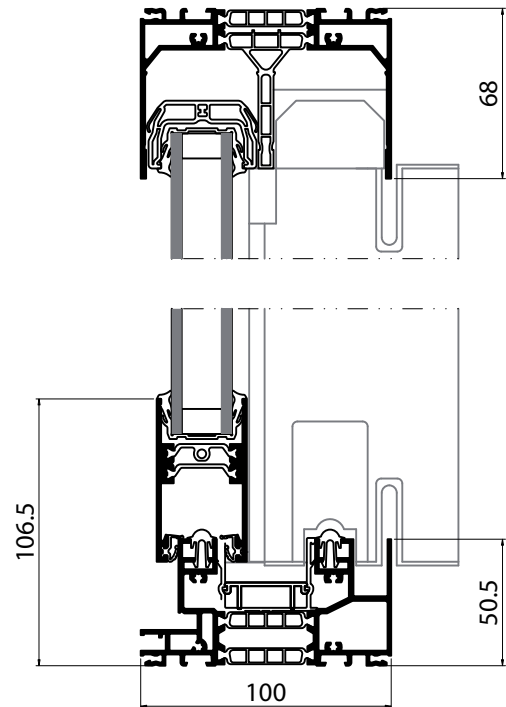

Coupe verticale

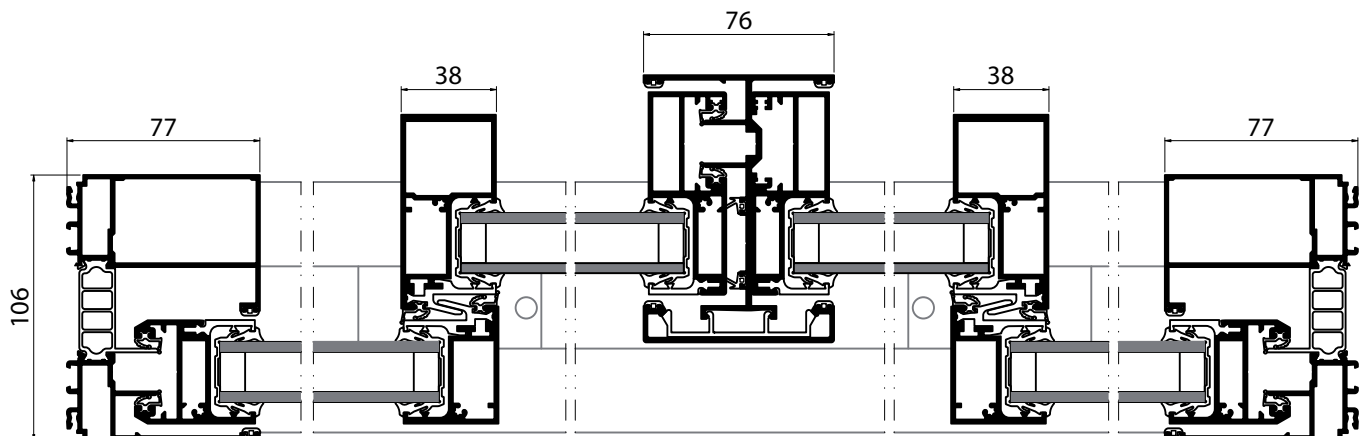

Coupe horizontale