

12/05 05 - 1.44

- Applications :

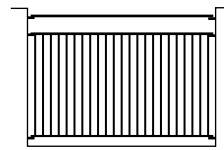

*droit entre tableau,
barreaudage sous lisse intermédiaire*

- Elévation, échelle 1/20 :

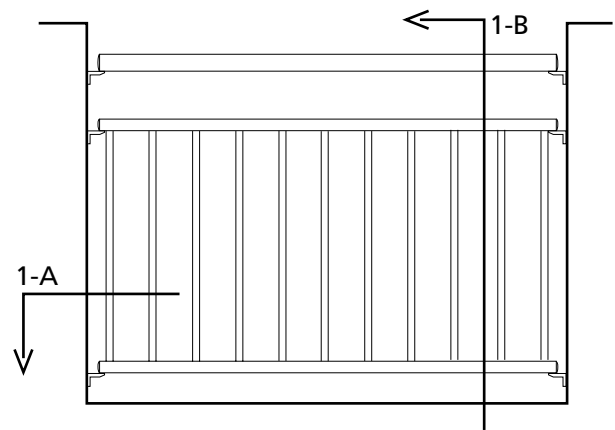

- lieu public : 1550 mm maxi.
- lieu privé : 1800 mm maxi.

- Coupes, échelle 1/2 :

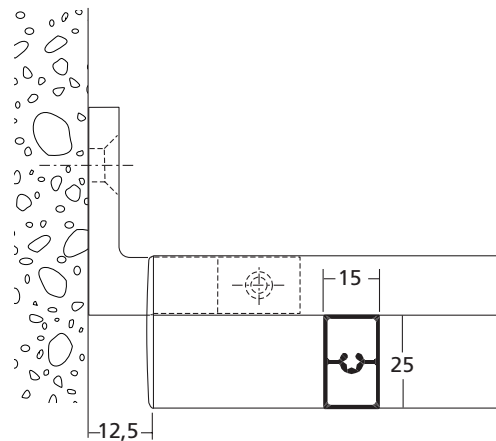

Coupe horizontale 1-A

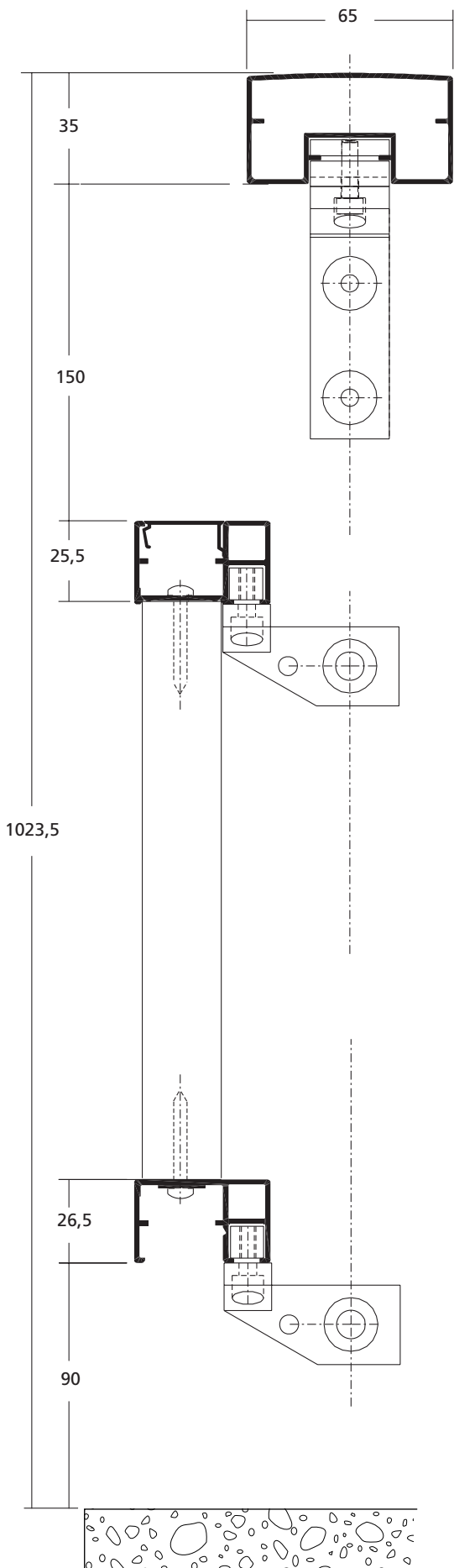

Coupe verticale 1-B